

T6 is a trade name of Trol Systems Inc.

TSI reserves the right to make changes to the information contained in this manual without notice.

publication T6+MAN, rev: 2 | © 2003 TSI All rights reserved | printed in USA

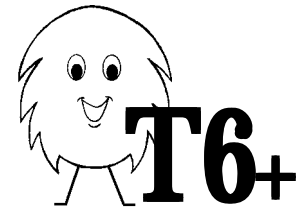

MCU-04-115  
&  
PGM-02  
User's Manual

Air-Oil Systems, Inc. www.airoil.com

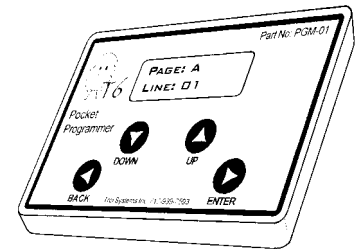
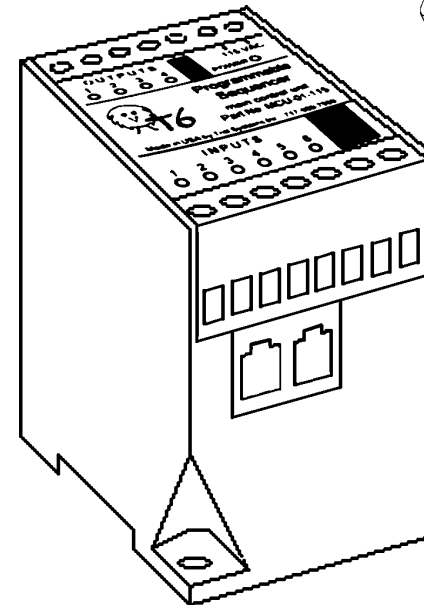

## Specifications

Part No: MCU-04-115, w/ Software Version: 3.3x

### Power Requirements

115VAC 50 or 60Hz @ .02A, 1000v magnetic isolation

### Outputs

4 normally open relay contacts unprotected, no leakage current

5Amps @ 115VAC (resistive load), 250 VA (inductive load)

10ma @ 5VDC (min. permissible load)

Rated life: 5 million mechanical / 200,000 @ 3A (w/resistive load)

Response time: 10ms operate / 5ms release

### Inputs

6 self powered, 12-14 VDC @ 10ma. w/1000v optical isolation

Maximum leakage of input device: 0.5ma

Response time: all are factory set at 10ms, the user may change any input from 0 to 255ms using the Setup Menu

### Auxiliary Power Supply

12-14 VDC @ 100ma. maximum, thermal overload protected

### Physical

Size 2.9" (75mm) x 2.2" (55mm) x 4.3" (110 mm)

Mounting DIN rail or panel (with two #6 screws)

Weight 10 oz. (284 grams)

Temp 0 - 140° F, 90% r. humidity (non cond.)

Origin Designed and assembled in the USA.

### Performance

Timing 0.01 to 59,999 seconds in 10ms resolution

Counting Repeat lines function, 59,999 maximum

Timing Accuracy + 1ms repeatability

Expansion 70 inputs / 68 outputs max, based on availability and configuration of I/O sections

## Introduction

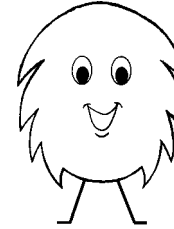

Congratulations on your wise choice to purchase a T6 machine controller. It's powerful, yet surprisingly easy to program. There isn't much that you'll need to learn... the T6 uses English as its language too! Please take some time out to read this short manual. Just one wrong connection could get your project off on the wrong foot!

The T6 is designed and manufactured in the United States by Trol Systems Incorporated. We specialize in simplifying industrial automation by developing unique products that are easy to use. Our best advertisement is You, by "word of mouth". So, if you find the T6 to be a product that is simple to use, at a great price... please tell others about it. That will help them out and us too! Future development of new products is largely based on our customer's requests and concerns. We value any comments and suggestions that you may have, so please... let us know.

Additional information, including the most recent edition of this manual is available on-line at:

[www.trolsystems.com](http://www.trolsystems.com)

If you should need help with the T6, contact your distributor. If you have a technical question that your distributor can't answer, we offer free factory direct support from 9AM to 4PM EST, Monday through Friday. Our technical support phone number is: 717-939-7593.

## Operation

You program the T6 by selecting functions that form lines of a page. The program looks similar to notes describing the order in which things should happen on your machine. These lines are executed in sequential order, from top to bottom. Therefore, the order in which you program the functions will allow you to build amazingly powerful sequences with great versatility. Each line must be completed before the next line is executed.

Functions that are completed right away (within 1ms):

a BLANK line  
turning an OUTPUT on, off or timing while on  
CONTROL A PAGE by thawing, freezing, resetting or moving  
END PAGE

Functions that are completed after certain conditions are met:

CHECK INPUT for on or off status  
CHECK OUTPUT for on or off status  
COMPARE INPUTS for all on, all off, any on or any off status

Functions that require an amount of time or count to occur:

WAIT for the selected amount of time  
REPEAT LINES for the selected number

Since not all things happen in a planned sequence, the T6 offers multiple pages. Each page can be programmed to perform a particular task or "sub-routine". This allows the T6 to be running more than one function at a time.

The T6 begins execution of Page A. All other pages are "Frozen", and cannot operate. As the sequence of Page A progresses, other pages can be "Thawed" into operation. Once thawed, the page will begin execution in the same way as Page A. Each page is checked one at a time to execute the current line of that page. This is done so quickly that the pages appear to be operating at the same time.

## Glossary

Default - A selection that is made automatically unless selected by the user to be different.

Dry Contact - A mechanical contact of a switch or relay that has no electronic characteristics such as leakage current.

Duration - The period of time something is either on or off.

Edit - To make a change to an existing program.

Falling Edge - The transition from on to off.

Input Device - Any device, such as a switch or sensor, that is wired to an input terminal.

Leakage - The current that flows through a device when it is off.

Line - The numbered part of a page that performs a selected function and is executed in sequential order.

Load - Any device wired to an output terminal.

Ma. - Milliampere or 1/1000th of an amp.

Menu - A list of possible choices that can be made.

Page - The lines of programming reside on a page which makes up a sequence. More than one sequence may run at the same time by programming more than one page.

Polarity - Requiring a connection to positive or negative.

Program - The lines of all pages are referred to as the program.

Prompt - The words, displayed while programming, that ask the user to make a selection.

Recognition Time - The period of time that is required for an input to be recognized as being valid and not noise or contact bounce.

Rising Edge - The transition from off to on.

Sequence - The program written for each page that is executed from top to bottom.

Sinking - A device that conducts a positive source of current.

T6 - The new standard for easy machine control - you knew that!

## Pages

There are a total of six pages. Page A has 200 lines and is where the main machine sequence is normally programmed. It may be the only page needed for applications where control of the machine is within a structured sequence. It determines when another page may operate- by thawing it or when a page may not operate- by freezing it. All other pages begin in the frozen state.



**REMEMBER!** Page A is the only page that is operational when power is applied. The other pages begin in a frozen state and must be thawed by Page A before they can operate. When Page A thaws other pages, it will continue operation too.

Pages B to F have 75 lines. These five pages are often used to control utility tasks such as continuously monitoring an input. They may also be used for sequences that are run at the same time as the main sequence (such as routinely cycling an output on and off to index a part feeder).

Here is an example of how the pages are programmed to work together in a coordinated manner.

**PAGE A** - main sequence  
01 CHECK INPUT 1 ON  
02 THAW PAGE B  
03 OUTPUT 1 ON  
04 CHECK INPUT 2 ON  
05 WAIT 0.50  
06 THAW PAGE C  
07 WAIT 1.0  
08 OUTPUT 3 ON  
09 OUTPUT 1 OFF  
10 CHECK INPUT 6 ON  
11 FREEZE PAGE C  
12 OUTPUT 2 ON  
12 WAIT 20.5  
13 OUTPUT 2 OFF  
14 CHECK INPUT 6 OFF  
15 CHECK INPUT 2 OFF  
16 THAW PAGE C  
17 WAIT 1.0  
18 FREEZE PAGE C  
19 END

**PAGE B** - makes sure Start switch stays on or will restart.  
01 CHECK INPUT 1 OFF  
02 OUTPUT 1 OFF  
03 RESET PAGE A  
04 END

**PAGE C** - if input 5 (hopper low), run hopper shaker.  
01 CHECK INPUT 5 ON  
02 FREEZE PAGE A  
03 OUTPUT 4 ON  
04 WAIT 1.5  
05 OUTPUT 4 OFF  
06 WAIT 1.5  
07 REPEAT 3, 10 TIMES  
08 THAW PAGE A  
09 END

## Safety

Safety is the most important aspect of any machine and must be considered at every step of design and fabrication. Since the **T6** may be used in such a wide variety of applications it would be impossible to cover all of them in this manual. Therefore, the user must determine if the controller is applied in an acceptable and safe way.

Programmable control equipment, such as the **T6**, use electronics and software to operate. When a failure occurs, unpredictable operation may take place regardless of the programming techniques used. For example; one or more outputs may suddenly energize. Therefore, your equipment must be designed to prevent property damage and personal injury in the event that such a failure may occur at any time.



### WARNING: IN THE EVENT OF FAILURE

Never reach into a machine to actuate a switch with your hand. An unpredictable and dangerous machine motion may occur. If an error in machine operation should occur, stay clear of the machine until power has been removed and all mechanisms have stopped.



### WARNING: NOT FOR MACHINE GUARDING

Under no circumstances should a general purpose control, such as the **T6**, ever be used as a means to protect or guard against personal injury. Nor should it be used to perform duties such as emergency stop, two-hand starting, or any safety related function. OSHA requires that "control reliable" equipment be used for such safety functions. The **T6** is not of "control reliable" design and is not intended for any safeguarding application.

## Installation

### Mounting:

The T6 should be housed in a suitable enclosure to seal out contaminants in the environment and to provide protection from exposed electrical components. As with any electronic device, the controller should not be mounted in areas of severe electromagnetic interference, vibration, moisture or temperature.

The T6 can be either DIN rail mounted or panel mounted using two #6 screws. It can be mounted horizontally or vertically. Leave space on the panel if additional equipment may be added to the system in the future.

### Wiring the Inputs:

Inputs allow the T6 to know what events are taking place on the machine. For example, a limit switch could be connected to an input so that the T6 would know when a cylinder has reached the end of its stroke.

At this point it is a good idea to get some lined notebook paper. Write down the input number and the name of the input device as you connect them to the T6. Then do the same for the outputs too. This information will be needed when you begin programming and it will come in handy for machine maintenance later.

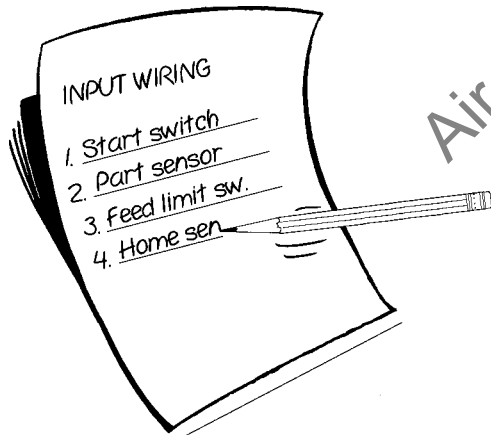

## Pages

Page A is often the only page required for many machine applications. Part of a machine sequence of Page A may look like this:

|    |                  |                              |
|----|------------------|------------------------------|
| 01 | CHECK INPUT 1 ON | (start switch is turned on)  |
| 02 | OUTPUT 1 TURN ON | (extend the feed cylinder)   |
| 03 | CHECK INPUT 2 ON | (reached end of feed stroke) |
| 04 | DELAY 0.50       | (allow the part to settle)   |

In this example, Input 1 must be on before line 2 turns on output 1. Then line 3 will check for input 2 to be on. The status of any other input is not of concern to this line. For example, line 3 will not detect if input 1 has turned back off. This may be totally acceptable for many applications; then only Page A is used.

But, what if we do need to detect if input 1 goes back off while we're trying to do other things? That's where the additional pages come in! The main sequence, such as in the previous example, is written on Page A. But, since our machine needs Input 1 to be constantly monitored, it is programmed on its own page. For example, if Page B where programmed to monitor input 1, it may look like this:

|    |                   |                         |
|----|-------------------|-------------------------|
| 01 | CHECK INPUT 1 OFF | (start switch is off)   |
| 02 | OUTPUT 1 TURN OFF | (retract feed cylinder) |
| 03 | RESET PAGE A      | (be ready for next run) |
| 04 | END               |                         |

Now whenever input 1 is turned off, Page B will respond to it. In the above example, it will retract the feed cylinder and reset the main sequence of Page A. However, Page A must allow the other pages to become operational. So in the first example, Page A will need to have a line added that would thaw Page B (as in the example on the following page).

Up to six pages may be thawed into operation at the same time. Once a page is thawed, it can be programmed to control other pages too. This allows the T6 to control even complex machine sequences! Learn how to use the page control functions by turning to page 19.

## Functions

### END PAGE

The sequence of this page is finished and it will now restart from line 1.

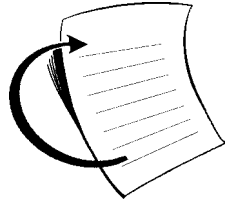

This function signifies that the sequence programmed on this page is complete and it will automatically restart again. Once a page is Ended, it cannot be changed without using the Edit menu. If you choose to "begin a new program" for the same page that you just programmed, the new program will replace the previous one.

Tip: Don't want the program of this page to be restarted? Then program the line just prior to the End with the Control Page function. Select the current page, then select it to be frozen. The page will freeze before it gets to the End. The page will need to be thawed by another page in order to be used again.

Note: After ending a page you will be prompted to "send the program". However, if you need to program additional pages, choose to do so now. But be careful not to select a page that is already programmed! When you end the last page, then proceed to send and run the program.

## Installation

The inputs of the T6 are self-powered and optically isolated to offer high noise immunity. The input voltage is +12vdc, which allows the inputs to interface to a wide variety of switches and sensors. The device wired to the input must be able to carry a minimum current of 10 milliampere. Input devices are wired between the input and either of the two common terminals as illustrated below.

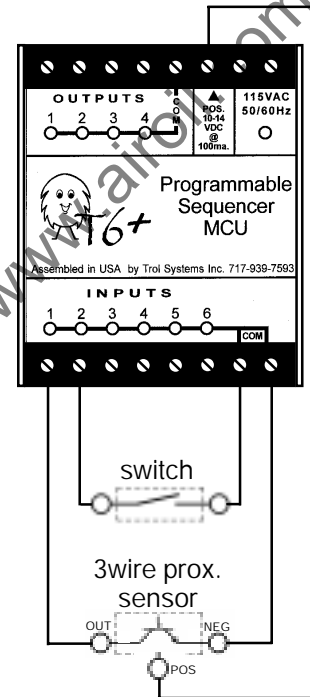

Electromechanical devices such as magnetic reed switches, limit switches, push button switches and pressure switches are wired with no regard to polarity (positive/negative).

Electronic devices such as magnetic hall effect transistors, photo-transistors, and DC proximity sensors must meet the following criteria:

It must be of an open collector NPN (like symbol in illustration). This is often referred to as being in a sinking configuration.

It cannot have an off current (leakage) greater than .5ma (.005 amp).

Note on three wire sensors: The Auxillary DC power supply terminal can be used to support sensors that require up to 100ma of current. If more current is needed, an external DC power supply is required (see optional equipment manual). The Auxillary supply measures

between 10-14volts, which is suitable for most 3 wire proximity sensors.

**Warning!** The inputs are self-powered and can be damaged if connected to an outside power source! Use a converter block (see the Optional Equipment booklet) if the input device is not of a dry contact or of a sinking configuration as required.

## Installation

Wiring the supply:

The T6 MCU requires a 115VAC supply to be connected to the first two terminals marked "115VAC", as shown below. It is good practice for the supply to be fused.

Wiring the outputs:

Each output consists of a normally open relay contact that can switch up to 5 amps at 115vac. These contacts share a common terminal marked "COM". If the loads are the same voltage as the supply, install a jumper as shown below. If the loads are of a different voltage than the supply, connect the common terminal of the outputs to a power supply suitable for the load devices. Each load is connected to an output terminal. The other side of the loads are connected to the common line of the supply. Use of a power distribution block (PDB-8\*) is an ideal way to make these connections

Inductive loads may greatly shorten the life of the output contacts. Use of a load suppressor (part number 30165\*) is highly recommended.

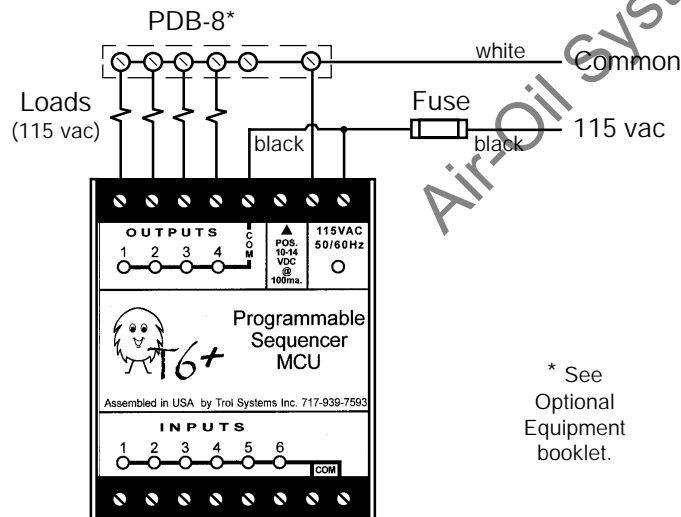

\* See  
Optional  
Equipment  
booklet.

## Functions

### CONTROL A PAGE

Allows a page to control the program execution of another page.

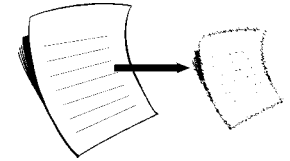

The selected page is frozen, thawed, reset or moved to a specific line. The function is completed and the next line of the page is executed. (Unless you set the line to freeze its own page).

Additional selections for this function are:

1. The page that you want to control. (A to F)
2. What the page should do (freeze, thaw, reset or move to line) as described below.
3. If Move, what line to move to.

### FREEZE

The current line of the page will cease operation. However, any output that may still be timing as a result of that page, will not be affected.

### THAW

Causes a frozen page to resume operation from the line where it was before it was frozen.

### RESET

Causes the selected page to halt execution of its current line and begin execution from line 1. If the page was frozen prior to being reset, it will remain frozen at line 1.

### MOVE TO LINE

Causes the selected page to halt execution of the current line and begin execution from the selected line. Can also be used on a frozen page so it will begin from the selected line when it is thawed.

Note: All pages except Page A begin in the frozen state and will not be operational until Page A executes a line that thaws them.

## Functions

### REPEAT LINES

Causes the page to go back and repeat previous lines.

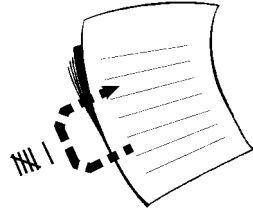

It will cause the page to go back to the selected line, then begin executing from that point. It will continue to repeat from that line for the number of times that you select, then the page goes on to the next line.

Additional selections for this function are:

1. The line number to go back to (from 1 to current line)
2. The number of times that it should repeat (0 - 60k)

To set the number, use the Back (◀) key to move the cursor left and the Enter (▶) key to move the cursor right. Moving the cursor to the far right will display the prompt OK?, When the Enter key is pressed then, the function is programmed at the selected number.

Tip on counting - Do you want an input (or output) to meet a count setting before going on to the next line? If so, program the previous two lines with the Check Input (or Check Output) function. Set one line for OFF the other line for On. Then use the Repeat Lines function to determine the count of the previous two lines.

Tip on repeating forever - If you need to repeat something forever, do not set this function to 60k! Remember, some functions are executed immediately (up to 1000 lines per second). So even though 60,000 times seems like forever... it isn't! Use the Control Page function and select the Move to Line option; then choose the same page that you're on and the line you want to repeat from.

Note: The Repeat Line function cannot be used to repeat any lines that also contain the Repeat line function. If it is, the first Repeat Line function will prevent the second one from being able to finish.

## Programming

The Pocket Programmer isn't just used to write the program. It serves as a guide when you run the program and retains a backup copy of the program. And don't worry... all devices in the T6 system use a type of memory that does not require power or batteries. If you're concerned that someone might try to mess up your program, consider locking the program with a password. (Use the Setup Menu for that). Let's take a quick look at the programmer:

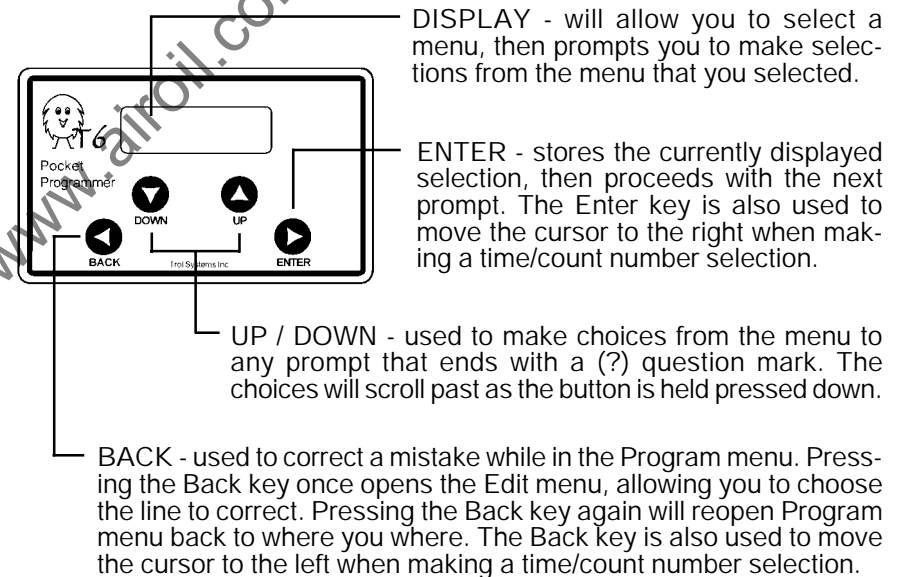

Before proceeding to write a program, take a lined sheet of notebook paper and at the top write Page A. Then, number the lines of the sheet.

As you program each line, remember to write it down. This will help you keep track of where you are and how your sequence occurs. Then, if any changes need to be made, editing will be a snap!



## Programming

First, the programmer must be given power. Should you run out of programming time, just turn off the power and you will be prompted to finish from where you left off the next time power is applied. The programmer receives power from one of these sources:

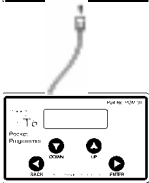
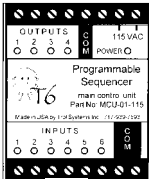

### Program at the machine

This method is sometimes uncomfortable for writing long sequences. However, it works out great whenever you need to edit or run your program.

This requires that the T6 Main Control Unit be wired for power as explained in the Installation chapter. First, make sure that the power is turned off before you plug the programmer into the data port. Then apply power.

### Program at a remote location

Programming in a quiet office will allow you to better focus on your machine's sequence. After you're done programming, you'll need to connect the programmer as shown above, in order to send the program to the T6 MCU. (Be sure to disconnect the power pack first).

An optional power pack (Pn: 30101) is required. Push the power plug into the socket on the side of the programmer until it is fully seated, then plug the power pack into a wall socket.

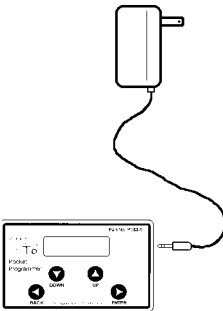

### **WAIT.. Have you tried any sample programming ?**

The Getting Started booklet offers an example and some programming tips. Give it a try; it only takes a few minutes, then you'll be off and running.

## Functions

### OUTPUT

Turns an output on, off, or will time how long it should be on.

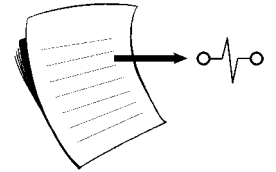

The selected output is turned on, turned off, or turned on for a selected amount of time. The function is now completed and the next line of the page is executed. Note: The page will begin the next line even if the output is timed on.

Additional selections for this function are:

1. Which output is to be controlled
2. What the output should do: turn on, turn off or timed\*.

If choosing the timed option, use the Back (⏪) key to move the cursor left and the Enter (⏩) key to move it right. Moving the cursor to the far right will display the prompt OK?, When the Enter key is pressed then, the output function is programmed at the selected time.

### CHECK OUTPUT

Checks an output to make sure that it is on or off.

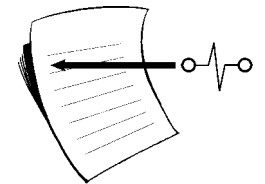

The selected output is checked to see if it matches the selected status of on or off. When it does, the function is completed and the next line of the page is executed. If the output is not at the selected status, the function can be set to move the page to a specific line number.

Additional selections for this function are:

1. The output to be checked
2. The status that the output must be: on or off.
3. If the output is not at the selected status, what line should this page be moved to? (If only the proper status is of a concern, just press enter at the default selection of "NO").

## Functions

### COMPARE INPUTS

Compares two or three inputs to determine if they match the selected status.

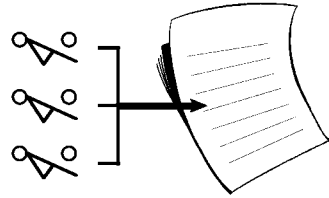

The selected inputs are checked to see if they match the selected status (as described below). When they do, the function is completed and the next line of the page is executed.

Additional selections for this function are:

1. The first input selection
2. The second input selection
3. The third input selection (enter zero if only two needed)
4. The status that the inputs must be:

ANY ON - at least one of the inputs must be on (logical OR).

ANY OFF - at least one of the inputs must be off (logical NOR).

ALL ON - all of the inputs must be on (logical AND).

ALL OFF - all of the inputs must be off (logical NAND).

### WAIT

Waits for a period of time before moving on to the next line.

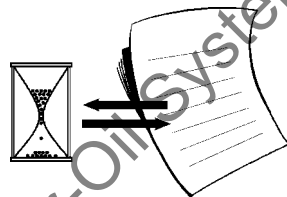

A time cycle will begin running. When the timer reaches zero, the function is completed and the next line of the page is executed.

Additional selections for this function are:

1. Delay time selection in seconds (0-59,999.99)

The Back (←) key moves the cursor left and the Enter (→) key moves the cursor right. Moving the cursor to the far right will display the prompt OK?. When the Enter key is pressed then, the line will be programmed with the Wait function at the selected amount of time.

## Programming

For a few seconds after power is applied, the display should read as shown, then the Main Menu will appear. Note: This manual is written based on version 1.5 or higher. If the display reads "program present", the existing program of the selected page will be overwritten should you proceed.

**version: 1.5  
not programmed**

At the Main menu, the first prompt will be "begin a new program", press the Enter key.

**BEGIN A NEW  
PROGRAM?**

Now you're in the Program Menu. First you must choose which page you want to program. Page A is where you'll want to begin; it's where the main part of your sequence will be. Often, it's the only page needed. Additional pages are available to perform tasks that are not within the main sequence of Page A. See the section on Pages for information on how other pages are used.

**program menu  
which page: A**

Once a page is selected, you'll be prompted to select functions for each line of the page. The lines are executed in the same sequence that they are programmed-- from top to bottom. These functions determine how your sequence operates.

**PAGE: A  
LINE: 001**

**which function?  
BLANK?**

The programming of the page will continue until you select the END PAGE function. Then the page is done and you will come back to the Main Menu.

Use the Up/Down keys to scroll through menu choices. Turn to page 12 which lists the Program menu choices. If you need a more in-depth explanation of what a particular function does, turn to the pages on "Functions".



Tip: Unless program size is a concern, program the odd numbered lines "Blank". This will help reduce the amount of erasing and renumbering in the event that the program needs to be edited in the future.

## Running the Program



**Remember,** before you can run the program it must first be sent to the T6. Don't worry; the programmer retains a full backup of your program without batteries or the power being applied.

**Sending the program:** The pocket programmer must be connected to the data port of the T6 MCU. If it isn't already, remove power from the MCU (disconnect the optional power pack if used), plug in the programmer, then apply power to the MCU. From the Main menu, select "Send T6 Program" and wait for the process to finish.

**Running the program:** At the Main menu, choose "Run Program". After a short system check, the MCU will begin running. Once in the run mode, it cannot be changed until power is removed, the pocket programmer is connected, and the power is reapplied.



**CAUTION:** The first time a machine is run can be especially dangerous. Stay clear of the machine until power is removed and all mechanisms have stopped.

While the T6 is running, the programmer will let you know what line is being executed and what the line was programmed to do. By default, it will always begin with Page A. Use the Up/Down keys to display the other pages.

```
page:a line:001
check input 1on
```

Remember, lines containing functions such as "Output" are executed in less than 1ms... so fast that you won't even see them be displayed!

If you run into problems, use the Edit Menu to make necessary changes to the program to correct things. Turn off the power to the T6 MCU; wait for five seconds before turning it back on. At the Main Menu, choose "Edit Program" and make changes. Be sure to send the edited program to the T6 MCU before you run it! Once everything seems to be working correctly, disconnect the pocket programmer and store it in a secure place.



**Notice:** If the pocket programmer is disconnected, the MCU will automatically run its program when power is applied.

## Functions

### BLANK

The line has no function but to take up space.

Lines are left blank so that if editing is necessary, the blank lines can be changed into useful functions. This avoids renumbering lines when one is inserted. Blank lines can also be used to make "buffer" spaces to separate different areas of the page that perform a particular task.



### CHECK INPUT

Checks an input to make sure it is on or off.

The selected input is checked to see if it matches the selected status of on or off. When it does, the function is completed and the next line of the page is executed. If the input is not at the selected status, the function can be set to move the page to a specific line number.

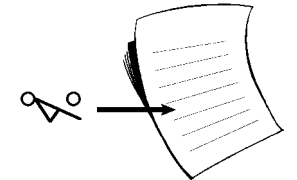

Additional selections for this function are:

1. Which input is to be checked.
2. The status that the input must be, either on or off.
3. If the input is not at the selected status, what line should this page be moved to? (If only the proper status is of a concern, just press enter at the default selection of "NO").

**Tip 1:** Do you want the input to be "edge triggered" (meaning that the input must change status from off to on)? If so, program the line for the input to be off and the next line for it to be on.

**Tip 2:** Do you want to count an input? If so, do as instructed in tip 1. Follow it by programming a line with the Repeat Line function. Set the count to what you want less one (because it would have already been cycled once to get to this line). Then choose the line to repeat from as the first one that checked the input.

## Setup Menu

The Setup menu is used to change T6 system operating parameters, such as adding I/O to the system.

- ERASE PROGRAM ?** □□  
□□
- After confirmation, all pages of the pocket programmer are completely erased (except bios settings). Do you also want to erase the program in the T6? If so, after erasing, go to the main menu and choose to "Send T6 Program". (Units must be connected)
- ADD I/O ?** □□  
□□
- Please follow instructions supplied with the I/O section being installed.
- REMOVE I/O ?** □□  
□□
- Please follow instructions supplied with the I/O section being removed.
- CHANGE PASSWORD ?** □□  
□□
- The programmer can be locked by setting a password. The password will be required in order to access the Main Menu. Choose eight characters (the password is case sensitive) and press Enter. The password is set after the eighth character is entered. Be sure to write down the password for safe keeping. To remove the password choose all blanks.
- CHANGE BIOS ?** □□
- Caution: Tampering with the settings in the BIOS memory (Page G) may cause problems in reliable operation! Therefore, you should not access the BIOS page unless specifically instructed to do so.

Setting the Input Speed: Each input of the T6 system is sampled a number of times before it is considered to be at a valid status (on or off). This eliminates the effects of contact bounce and noise. However, it also slows down the speed at which the input will be acknowledged by the program. You may adjust the speed of each input in the system by changing the number in its BIOS register.

Register 1A=input number 1, 2A=input number 2, and so on up to 99A (MCU inputs are 1A to 6A). Choose an input that you want to adjust. The input's current setting is now displayed (factory preset is 10ms). Adjust the speed setting from 0 to 255ms.

Remember, changes to the programmer will not affect the machine operation until the program is sent to the MCU.

## Main Menu

The main menu is the first to appear when power is applied to the programmer. Press the □ □ Up or Down selection keys until the display reads what you'd like to do, then press the Enter key.

- BEGIN A NEW PROGRAM?** □□  
□□
- Turn to "Program Menu" (page 12). Caution: any previous program of the selected page will be replaced with the new one, if you proceed.
- EDIT CURRENT PROGRAM ?** □□  
□□
- Turn to "Edit Menu" (page 13).
- SETUP T6 OPTIONS ?** □□  
□□
- Turn to "Setup Menu" (page 14).
- \* **RECEIVE T6 PROGRAM ?** □□  
□□
- The program of the MCU is copied into the memory of the pocket programmer. Caution: the program in the programmer will be replaced by the one that is received from the MCU.
- \* **SEND T6 NEW PROGRAM ?** □□  
□□
- The program of the pocket programmer is copied into the memory of the MCU. Caution: the program in the MCU will be replaced by the new one. Turn to "Running the Program" (page 10).
- \* **RUN PROGRAM IN T6 ?** □□
- The program of the MCU will be executed. Turn to "Running the Program" (page 10).

\* Note: The last three menu choices only appear if the pocket programmer is connected to the data port of the MCU prior to applying power. Be sure to remove the optional power pack (if used) from the programmer.

## Program Menu

**PROGRAM MENU  
WHICH PAGE: A**

Select the page that you want to program, then press Enter. (First time users should start by selecting page A). Caution: If the selected page was already programmed, use the Edit Menu. Otherwise, the page will be overwritten when you proceed with the Program Menu. Pressing the Back key opens the Edit menu, allowing you to make corrections. Pressing the Back key one more time returns the Program menu.

**PAGE: A  
LINE: 001**

The line number is momentarily shown before you are prompted to select the function for the line.

**WHICH FUNCTION:  
BLANK?**

Leaves a blank line to make space in case the program needs to be edited.

**WHICH FUNCTION:  
CHECK INPUT?**

Checks an input to make sure that it is either on or off. If not of the proper status, the function can be set to move the page to a specific line.

**WHICH FUNCTION:  
COMPARE INPUTS?**

Compares two or three inputs to verify that they are all on, all off, if any are on, or if any are off.

**WHICH FUNCTION:  
OUTPUT?**

Turns an output on, off or will time how long it should be on for.

**WHICH FUNCTION:  
CHECK OUTPUT?**

Checks an output to make sure that it is either on or off. If not of the proper status, the function can be set to move the page to a specific line.

**WHICH FUNCTION:  
WAIT?**

Waits for a period of time before execution of the next line.

**WHICH FUNCTION:  
REPEAT LINES?**

Goes back to repeat a line of this page for a selected number of times.

**WHICH FUNCTION:  
CONTROL A PAGE?**

Allows this page to control the program execution of another page.

**WHICH FUNCTION:  
END PAGE?**

The last function of a page, which causes the page to restart execution from line 1. After selecting this function you will be returned to the Main menu.

## Edit Menu

The Edit menu is used to make changes to an existing program or to view the contents of a line. Once in the Edit menu, pressing the Back key will return you to the previous menu.

**EDIT MENU  
CHOOSE PAGE:**

Choose the page (A to F) that contains the program you want to edit. Press the Back key to exit the Edit menu.

**PAGE: A LINE:1  
CHECK INPUT 01**

Choose which line you want to edit. The bottom line will then display what that line is currently programmed to do.

**PAGE: A LINE:1  
FOR STATUS: ON**

**LINE: XXX  
CHANGE IT?**

Make a selection of a function from the Program menu. When the line being changed has a setting (such as time), you will be offered the option of changing just the setting or the entire line. The new selections will replace the previous one for this line. Please note the change of the line on your tablet at this time. If you changed a line containing the "End Page" function, the Program menu will continue until you re-select the "End Page".

**LINE: XXX  
DELETE IT?**

When a line is deleted, the lines below are moved up by one to fill the gap and must be renumbered. Consider changing the line to the "Blank" function rather than deleting it. This would eliminate the need to renumber. If you want to delete all lines of all pages, use the Setup Menu (page14).

**LINE: XXX  
INSERT A LINE?**

Make a selection of a function from the Program Menu. The new line is inserted before the current line selected. All lines below that line move down by one to make room for the new line. Please renumber those lines and make note of the inserted line at this time.